

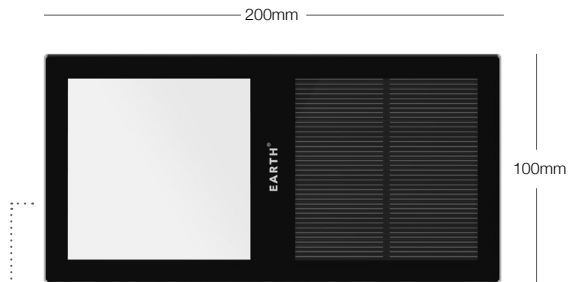

BRICK

General Dimensions



Why using BRICK Solar lamp?

Product features



EARTH Brick meets all the requirements of standard EN 60598-2-13 regarding vehicle and pedestrian use and are therefore ideal for lighting all the areas provided for by the regulations, such as car, parks, pedestrian zones and other designated areas.

Drainage base

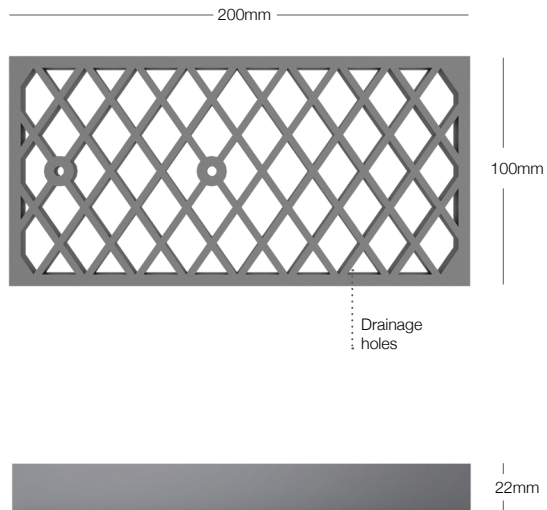

Lamp elements

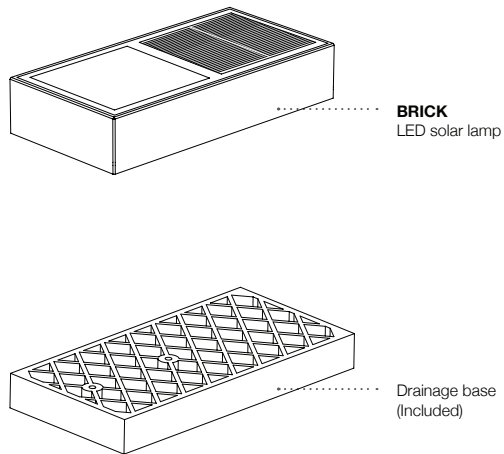

Connect the lamp and the drainage base, by screwing together

Installation in flexible pavings

1

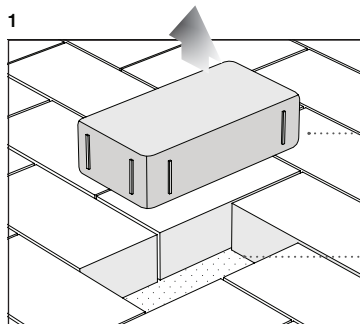

..... In existing pavings, extract the selected paving block.

..... Draining sublayer (ex. sand)

2

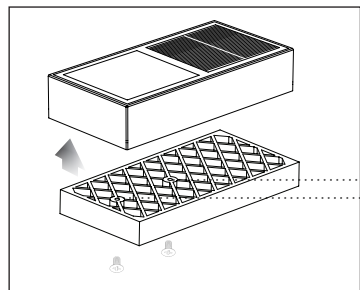

..... Connect the lamp and the drainage base by screwing together. (screws are included in the packaging).

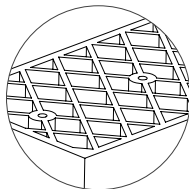

Installation in flexible pavings

3

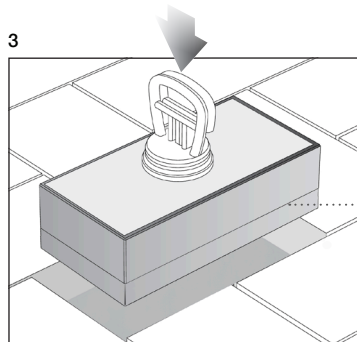

..... Insert the lamp using the suction cup, in order to hold the product correctly and avoid possible damages.

4



..... Once the lamp is correctly located in the pavement, the protective plastic film can be removed from the glass surface.

Installation in solid pavings

1

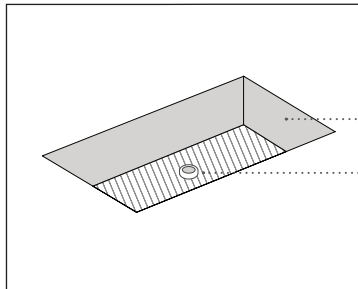

Reserve the space in the ground in which **BRICK** Solar lamp will be installed
at least: 100x200mm
Depth:6cm

Drainage tube (Not provided)

2

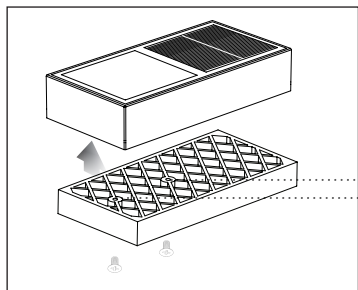

Connect the lamp and the drainage base by screwing together. (screws are included in the packaging).

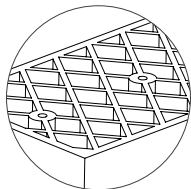

Installation in solid pavings

3

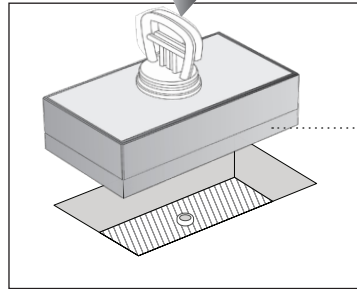

Insert the lamp using the suction cup, in order to hold the product correctly and avoid possible damages.

4

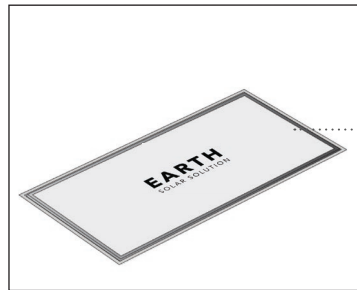

Once the lamp is installed, remove the protective plastic film from the glass surface.

Turn ON the lamp

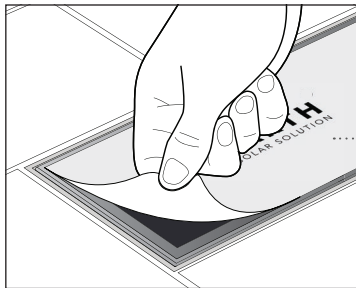

Once the lamp is in contact with light is activated and automatically turns on in the night.

General Analysis

Functions and efficiency



Automatic Operation
Photovoltaic-photosensitive Solar Panel.



Light Temperature:
3.500 Kelvin (warm white)
4.500 Kelvin (light yellow)



Brick Solar lamp can work more than 3 days without a favorable weather when fully charged

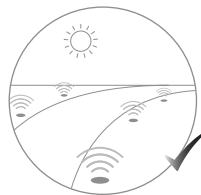

For maximum efficiency we recommend you to Install **Brick** solar lamp where it can get direct sunshine, free from cover or shade.

Lamp spacing

We recommend you to install the lamp with a distance from each other of approximately: 1.10 mts.

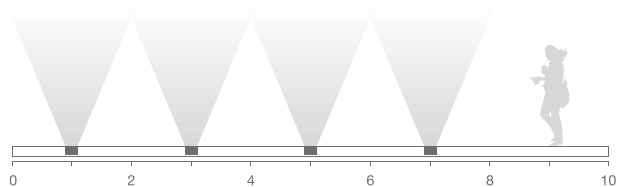

Other compositions

The lamp could also be installed in pairs or groups, in order to have a stronger and more focused light.

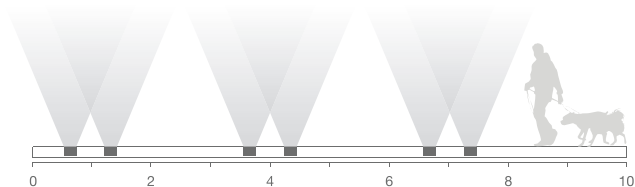

Product specifications

Model No	E.BR.01
Weight	0.950 Kg
Material and Colour	Dark grey Anodized Aluminum and glass
Battery type	LiFe PO4
Battery replacement	Every 5 years
Battery capacity	1 X 1.500mAh, 3.2V
Max. static load	15kN
Max. Temp	< 30 °C
Manufacturer	Vesta S.r.l

Duration	Aprox. 13 hours
Min. charging time	Aprox. 4 to 6 hours
Dimensions	100mm x 200mm x 60mm (with Drainage base)
Solar panel output	1 Watt

LED power	0.08 watt
Lighting colour	3500 K - 4500 K
Battery Oper. Temp	-20°C ~ 80°C



IP68
10m





Trouble shooting

If your solar charged lamp does not come on at dusk despite the observance of all the instructions please try the following steps:

1. Make sure that the lamp is not being affected by any other light source.
2. Ensure the lamp does not stand in the shade during the day.
3. Check that the battery is installed correctly.

Maintenance

Clear the solar module regularly with a damp towel to guarantee optimum performance of the solar panel.



Important

This product must be installed by qualified personnel in paving installations. **Earth Solar Solutions** is not responsible if its fixtures are not installed according to local safety standards.



Disposal

Electronic devices do not belong to your household waste. Compliant with European Guideline 2002/96/EG for electric and electronic devices, used electronic devices must be collected separately and taken in for environmentally sound re-cycling. Options for disposing of used devices may be obtained from your township, city or municipal government.

Incorrect disposal of batteries can harm the environment!

Batteries can contain poisonous heavy metals and are subject to treatment as hazardous wastes. Take your used batteries to a municipal collection site.

Battery to be replaced by experienced personnel only.

The light source of the luminaire is not replaceable. When the light source reaches its end of life the whole luminaire shall be replaced.

MADE IN ITALY

Concept by **EARTH Solar Solutions**

Designed, developed and engineered by **Mandalaki** in coordination with **EARTH®**

BRICK model produced by Earth Solar Solutions. All intellectual property rights and copyrights are reserved. Nothing contained in this brochure may be reproduced without written permission. All rights reserved. Made in Italy.



This document was printed from recycled FSC-certified paper. **FSC**

